User Manual

Dual Sheer Shades

Thank you for purchasing custom dual sheer shades. With proper installation, your shades should look beautiful and provide years of service. Please check all parts and review this manual before starting installation.

Keep this manual after your shades are installed and operating correctly. It contains important programming and troubleshooting instructions for your shades.

CONTENTS:

- Page 1:** Mounting Hardware and Required Tools
- Page 2:** Installing Your Shade
- Page 3:** Installing Chain/Cord Tensioner
- Page 4:** Wand Control - Preparing and Operating
- Page 5:** Wand Control - Troubleshooting
- Page 6:** Remote Control - Preparing Motor and Remote
- Page 7:** Remote Control - Operating
- Page 8:** Remote Control - Troubleshooting
- Page 9:** Wand and Remote Control - Changing/Resetting Limits
- Page 10 - 11:** Troubleshooting Shades
- Page 12:** Shade Warranty

MOUNTING HARDWARE:

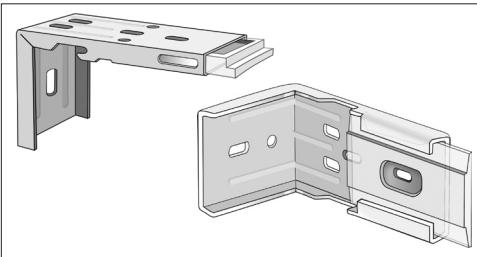

**Universal Mounting Brackets and Screws
(for inside/top and outside/face mounting)**

Ordered Width (Inches)	Brackets Supplied
Up to 54"	2 Brackets
Between 55" and 78"	3 Brackets
Between 79" and 98"	4 Brackets
Between 98" and 110"	5 Brackets

TOOLS THAT MAY BE REQUIRED:

Pencil, Tape Measure, Drill, Screw Driver, Level, and Step Stool

INSTALLING YOUR SHEER SHADE

NOTE: For wallboard or plaster, use anchors designed for hollow walls (not included). For concrete, stone and brick, use a masonry drill bit and masonry anchors (not included).

STEP A: INSTALL BRACKETS

Your sheer shade will come with universal brackets for inside (top) or outside (face) mounting. **[Figure 1]**

- 1. Before beginning installation, fit the brackets into the cassette.** See how the white plastic bracket lip fits under the front rib of the cassette, and then push on the back of the bracket to compress it until it snaps into place. The hooks on the bracket are now caught on the back rib of cassette. Push again on the bracket back to remove it.
- 2. Mark the desired position of the brackets with a pencil.** Position one bracket within 2" from each end cap of the cassette. Then space out any middle brackets equally (if supplied). Check the table on page 1 to see brackets supplied by shade width. **NOTE:** It is extremely important to install all brackets provided, making sure that any middle brackets are equally spaced. This is required to ensure that your shade will hang with no waviness in the fabric. For more details see Bracket Installation troubleshooting on page 11.
- 3. Drill pilot holes for the screws.**
- 4. Use provided screws to install brackets.** Ensure that they are level and in line with each other. If they are not level, the cassette may not snap properly into all of the brackets.

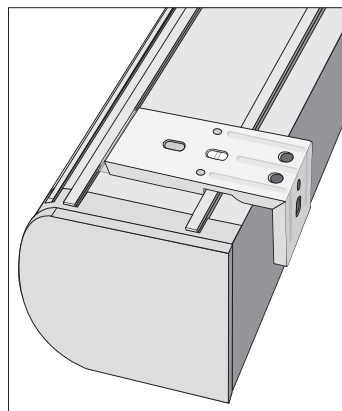

Figure 1: Cassette and Bracket

STEP B: INSTALL SHEER SHADE

- 1. Position the bracket under the front rib on the cassette.** Tilt the front of the dual sheer up and hook the white plastic bracket lip under the front rib on the top of the cassette.
- 2. Snap cassette into place*.** Now push the cassette back and up until all brackets snap into place.
- 3. For shades ordered with clutch controls,** follow instructions on page 3 for installing the tensioner. **For motorized shades,** move on to page 4 for wand control or page 6 for remote control.

* For shades ordered with motorized control options, it is a good idea to make sure the motor is fully charged before snapping the cassette into place. Follow the instructions on page 4 for charging wand control shades and on page 6 for charging remote control shades. Shades using wand control should also have the wand installed before snapping cassette into place; see instructions on page 4.

INSTALLING CHAIN/CORD TENSIONER

Sheer shades ordered with clutch controls have a continuous loop which must always be secured to the wall with the included tensioner. Follow the instructions below for installing the tensioner.

1. **Select the right location.** The chain/cord tensioner should be installed on a flat surface, so the loop is taut, but not stretched. **[Figure 2]**

Inside mount: The tensioner may be attached to the windowsill or to the inside of the window frame.

Outside mount or wall mount: The tensioner may be mounted to the exterior of the window frame or wall.

2. **Mark the desired location** of the screw holes for the tensioner with a pencil.
3. **Drill pilot holes for the screws.**
4. **Use provided screws to install the tensioner.** Ensure that it is fully compressed so that the springs are pushed in and the chain or cord loop passes smoothly through the guide hole. **[Figure 2]**

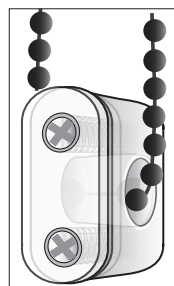
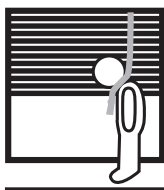

Figure 2: Tensioner with beaded chain loop

NOTE: The chain/cord tensioner performs an important safety function by keeping loops away from small children. Never operate the shade without a functioning and correctly installed tensioner.

⚠️ WARNING



Window Blind Cord Can STRANGLE Your Child.

To prevent strangulation, purchase cordless products or products with inaccessible cords.

ANSI/WCMA 5.1.3

⚠️ ADVERTENCIA

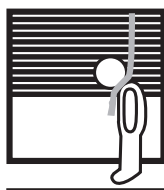

La cuerda ciega de la ventana puede ESTRANGULAR su niño.

Para evitar el estrangulamiento, compre alternativas inalámbricas o productos con cables inaccesibles.

ANSI/WCMA 5.1.3

WAND CONTROL - PREPARING AND OPERATING

CONNECT THE WAND TO THE MOTOR

Before installing your shade, attach the wand to the motor.

1. **Lift the protective cover** on the motor interface and insert the plug on the end of the wand cable into the motor interface in the end of the tube. Take care to ensure the plug is correctly aligned.
2. **Insert the hook** on the end of the wand into the eyelet on the motor crown and push it all the way through so the wand hangs down freely.

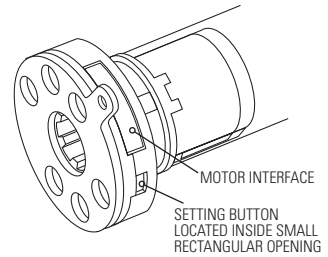

Figure 3: Wand Motor Head

CHARGING THE MOTOR

We recommend ensuring that the motor battery is fully charged before installing your shade.

1. **Plug the charger into the micro USB port** on the back of the wand [Figure 4] and then plug into an AC outlet. If the battery is fully charged, the LED light will glow green. If not, leave the wand to charge until the LED is green.
2. **Unplug the charger** when the LED light glows green.

NOTE: The motor battery is in the shade tube, not the wand.



Figure 4: Wand Charging Port

OPERATING THE SHADE

Your shade has been programmed at the factory with an upper and lower stop limit. This means it will automatically stop when the shade is fully raised or lowered.

Once your shade is installed, check the operation. The wand has three buttons: **UP**, **STOP** and **DOWN**. [Figure 5]

- Press the **UP** button to raise the shade to pre-set upper stop limit.
- Press the **STOP** button to stop the shade at any desired location.
- Press the **DOWN** button to lower the shade to pre-set lower stop limit.

If the shade stop limits require reprogramming, follow the instructions on page 9.

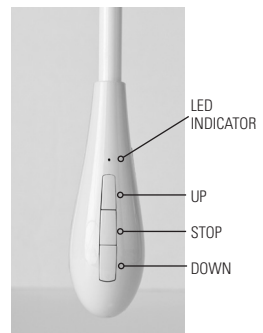

Figure 5: Wand Control Buttons

WAND CONTROL - TROUBLESHOOTING

WAND WILL NOT OPERATE THE MOTOR

1. Make sure the motor is charging:

- Use a pencil eraser to push firmly on the wand plug and ensure that it is fully seated in the motor interface. **[Figure 3]**
- Re-charge the battery; see instructions on page 4.
- If you were able to re-charge the battery, the wand should now operate your shade.

2. If after re-charging the battery the shade still won't operate, check the motor. Use an opened paperclip to press the setting button on the motor crown **[Figure 3]**

- If the shade moves, press the setting button again to stop the shade. Contact customer service to obtain a new wand.

Note: The motor retains all its programming; just connect the replacement wand to the motor.

- If the shade doesn't move, the motor is defective and needs to be replaced. Contact customer service to obtain a new motor.

Note: You will need to program the replacement motor with stop limits. Once you install the new motor, follow the resetting stop limits instructions on page 9.

NO LED LIGHT SHOWING

If during charging there is no LED light (red or green) showing,

- Check the connection between the wand and the motor. Use a pencil eraser to push firmly on the plug and ensure that it is fully seated.
- If the connection is good, but no LED light visible, then the wand needs to be replaced. Contact Customer Service to obtain a replacement wand.

RESETTING THE SHADE MOTOR

If you need to remove all shade stop limits and start over, follow these steps:

- 1. Press & hold the Setting Button [Figure 3]** on the motor crown until the shade jogs 3 times. This removes all programming. **NOTE:** There is a longer pause between the 2nd and 3rd jogs.
- 2. Set upper and lower limits;** see instructions on page 9 for resetting shade limits.

REVERSING SHADE DIRECTION

If for some reason the shade direction is reversed, press & hold the Setting Button **[Figure 3]** on the motor crown until the shade jogs 2 times.

REMOTE CONTROL - PREPARING MOTOR AND REMOTE

CHARGING THE MOTOR BATTERY

The shade battery is inside the motor, encased in the shade tube.

To charge the motor battery:

- Insert the charging cord into the charging port on the end of the shade tube **[Figure 6]**, and plug the other end of the power adaptor into an outlet.
- When the LED on the end of the shade tube changes from red to green, the motor is fully charged.

If the motor battery needs to be charged, it will beep 10 times when you press any button on the remote control.

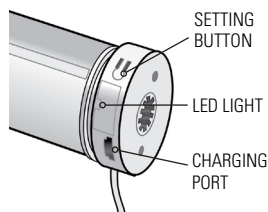

Figure 6: Motor End

PREPARING THE REMOTE

Remove the panel on the back of the remote and pull out the insulating paper tab used to protect the battery during shipment **[Figure 7]**.

When you press a button on the remote, you will see blue LED back light in between the buttons.



Figure 7: Remote with battery cover removed

CHANGING THE REMOTE BATTERY

If the blue LED back light between the remote buttons doesn't show when you press Up, Down, or Stop, it is time to replace the battery.

- The remote should operate your shades from a distance of up to 100 feet, but low remote battery power can shorten this distance.
- Sometimes there is enough power to display a channel number on the LED screen of a multi-channel remote, but not enough to signal the motor and operate the shade.

The remote control uses a **CR2450 battery**, available at most hardware/general stores.

PAIRING REMOTE

1. **For a multi-channel remote**, select channel first (Do not select Channel 0).
2. **Press & hold the Setting Button [Figure 6]** on the shade motor end until the shade jogs once; let go and you'll hear a long beep.
3. **Quickly press the UP button**; shade will jog once and beep 3 times.
Note: Once motor jogs, you must press UP within 20 seconds.

UN-PAIRING SHADE FROM THE REMOTE/CHANNEL

Follow "PAIRING THE SHADE..." steps, but press the **DOWN** button instead.

REMOTE CONTROL - OPERATING

Hand held remotes or wall switches are available in single-channel and multi-channel options. Both single-channel and multi-channel remotes or wall switches have the same operational instructions. Multi-channel remotes or wall switches are capable of operating shades on more than one channel.

- If using a multi-channel remote or wall switch, press the “<” or “>” button to select the correct channel.
- Press (and release) the **Up** or **Down** button and the shade will move to the upper or lower stop limit set by the factory. To change the stop limits, follow the instructions on page 9.
- Press (and release) the **Stop** button:
 - While the shade is raising or lowering to stop it at that point.
 - When the shade is not moving to go to the set middle limit.Follow the instructions on page 9 to set the middle stop limit.

MULTI-CHANNEL REMOTE

Multi-channel remotes [Figure 8] or wall switches are used to control several shades independently with just one remote.

- 15 channels can be programmed.
- A single shade or group of shades can be pre-programmed to operate on a specific channel, as identified on the order.
- Channel 0 is the group channel; it operates all shades at once.

FINE TUNING BUTTONS

You can fine tune your shade’s position by using the reverse arrows on your remote. [Figure 8]

- Use the upper reverse arrow (clockwise) to raise your shade 1/8” at a time
- Use the lower reverse arrow (counter-clockwise) to lower your shade 1/8” at a time

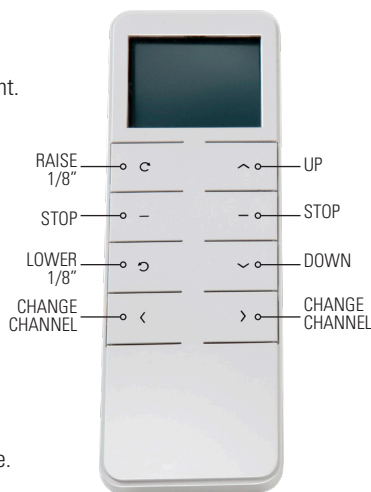

Figure 8: Multi-Channel Remote

REMOTE CONTROL - TROUBLESHOOTING

REORGANIZING SHADES ON A MULTI-CHANNEL REMOTE

- To move a shade from one channel to another, see instructions below

Contact Customer Service for assistance/instructions on:

- Moving a group of shades from one channel to another
- Copying programming from one remote to another

MOVING A SHADE FROM ONE CHANNEL TO ANOTHER

The simplest way to move a shade (and the set stop limits) from one channel to another is by un-pairing and pairing the shade to channels on the remote. Follow **Pairing/Un-Pairing Shade From Remote/Channel** instructions on page 6.

Example: Left and right shades in the dining room are on separate channels, but you want them to move together. Just follow these two steps:

1. Select channel 2 and un-pair the right shade.
2. Select channel 1 and pair the right shade to it.

Now both dining room shades are on the same channel (#1) and will move together.

Before

Channel 1: LEFT shade
Channel 2: RIGHT shade

After

Channel 1: LEFT & RIGHT shades
Channel 2: ~~RIGHT shade~~

RESETTING THE SHADE MOTOR

If you need to remove all shade stop limits and start over, follow these steps:

1. **Press & hold the Setting Button [Figure 6]** on the shade motor end until the shade jogs 4 times then beeps 3 times. This removes all programming.
NOTE: There is a longer pause between the 2nd and 3rd jogs.
2. **Reset upper and lower limits.** See instructions on page 9 for setting shade limits.

REVERSING THE ROLL DIRECTION

If for some reason shade direction is reversed:

Press & hold the Setting Button [Figure 6] on the shade motor end until the shade jogs 3 times.

WAND AND REMOTE CONTROL - CHANGING/RESETTING LIMITS

CHANGING PRESET UPPER AND LOWER STOP LIMITS

If you are changing preset stop limits, follow the instructions below.

NOTE: When changing limits, the motor is in “program mode” and only moves in small increments. To move shade more quickly, press & hold UP or DOWN button until the shade moves continuously.

CHANGE THE **UPPER STOP** LIMIT:

1. **Press UP** to move the shade to the current pre-set upper stop limit.
2. **Press & hold UP&STOP** buttons together until the motor jogs once, then beeps 2 times.
A “jog” is a quick, small up-and-down movement.
3. Move the shade to the desired upper stop limit.
4. **Press & hold UP&STOP** buttons together until the motor jogs 2 times and beeps once.

CHANGE THE **LOWER STOP** LIMIT:

1. **Press DOWN** to move the shade to the current pre-set lower stop limit.
2. **Press & hold DOWN&STOP** together until the motor jogs once, then beeps 2 times.
3. Move the shade to the desired lower stop limit.
4. **Press & hold DOWN&STOP** buttons together until the motor jogs 2 times and beeps once.

CHANGE (OR SET) THE **MIDDLE STOP** LIMIT:

This motor also has a middle stop position capability. Setting this limit is left to the customer.

1. Move the shade to the desired middle stop limit.
2. **Press & hold STOP** button for 5 seconds until the motor jogs once and beeps once.
A “jog” is a quick, small up-and-down movement.
3. To confirm that you’ve set this limit, move the shade to another position. Then while the shade is not moving, press the STOP button and the shade should move to the set middle stop limit.

RESETTING UPPER AND LOWER STOP LIMITS (FROM FULL RESET)

If your shade motor requires resetting, follow the instructions below to set your stop limits.

NOTE: When starting from a full reset, the motor is in “program mode” and only moves in small increments. To move shade more quickly, press & hold UP or DOWN button until the shade moves continuously.

SET THE **UPPER STOP** LIMIT:

1. **Always set the upper limit first** when adding limits after a full reset.
2. Move the shade to the desired upper stop limit.
3. **Press & hold UP&STOP** buttons together until the motor jogs 2 times and beeps once.
A “jog” is a quick, small up-and-down movement.

SET THE **LOWER STOP** LIMIT:

1. **Always set the lower limit second** when adding limits after a full reset.
2. Move the shade to the desired lower stop limit.
3. **Press & hold DOWN&STOP** buttons together until the motor jogs 2 times and beeps once.

SET THE **MIDDLE STOP** LIMIT: Follow instructions above for setting the middle stop limit.

TROUBLESHOOTING SHADES

SHADE FABRIC IS OVERWOUND

Dual sheer shades are designed so that both layers of the fabric panel are at the back of the shade roll with a very small gap between them [Figure 9]. If shades become overwound there will be a larger gap and less light blockage [Figure 10].

To correct an overwound shade:

- Lower the shade fully.
- Once fully lowered, continue lowering the shade and notice that the fabric will start to wind around the back of the tube, closing the gap between the two layers.
- To keep shades from becoming overwound:

Clutch Control Shades:

- **Raise** using the **front** of the cord/chain loop.
- **Lower** using the **back** of the cord/chain loop.

Wand or Remote Motorized Shades: Always set stop limits that are not in an overwound position.



Figure 9: Shade fabric comes off back of roll

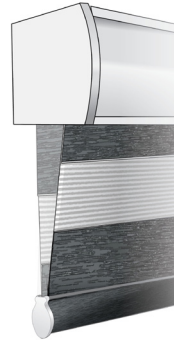

Figure 10: Overwound shade fabric

SHADE FABRIC IS NOT ALIGNED

The back panel of dual sheer shades should be perfectly in line with the front panel to ensure proper operation [Figure 11]. If the panels are not aligned, it can result in frayed fabric edges or waves in your shade fabric [Figure 12].

To correct unaligned shade fabric:

- Start by fully lowering the shade.
- Then, gently pull the back fabric panel in line with the front [Figure 13].

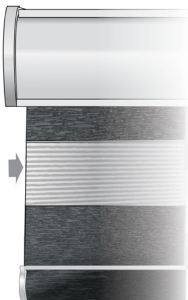

Figure 11: Shade fabric aligned

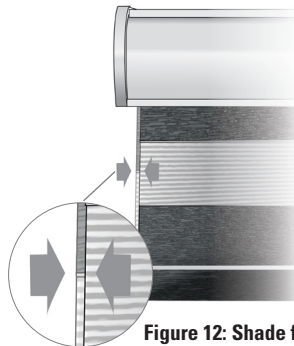

Figure 12: Shade fabric not aligned



Figure 13: Correcting unaligned fabric

TROUBLESHOOTING SHADES (continued)

SHADE FABRIC IS WAVY

If dual sheer shade fabric appears wavy after the shade is installed, review the notes below:

Shade Fabric Not Aligned

- If the front and back panels of the dual sheer shade are not perfectly aligned, waviness in the fabric can occur. Follow the instructions on page 10 for correcting unaligned shade fabric.

Bracket Installation

- It is very important to install dual sheer shades using all brackets provided. See the chart on page 1.
- Ensure that the brackets are properly spaced. The brackets on the two far ends of the shade should be spaced within 2" from either shade end cap. If more than two brackets were supplied, they should be spaced evenly between the two end brackets.
- Also ensure that brackets are installed in a straight line across the window. If brackets are not aligned, it can force the cassette to warp (or bend) when snapped into the brackets, leading to waviness in the shade.
- Proper bracket installation will allow balance for the shade and alleviate waviness.

Shade Static

- If the shade is still showing waves through the fabric after checking that the fabric is aligned and the brackets are installed properly, try spraying liquid anti-static on the shade.

If there is still waviness in your shade after trying these tips, contact customer service.

SHADE WARRANTY

WHAT IS COVERED BY THIS WARRANTY?

This shade is warranted against defects in materials and workmanship, provided that:

1. The product was installed according to the product instructions.
2. Our recommendations were followed regarding limitations and specifications of the product.

We reserve the right to determine if your shade warrants a repair or partial replacement of any parts. If necessary, we will replace your shade with a new shade of equal or superior value. This shall be your sole remedy under this warranty.

All motors, remote controls and wand motors are warranted for a period of five years from the date of purchase.

WHO IS COVERED BY THIS WARRANTY?

This warranty applies only to the original retail purchaser with proof of purchase in the USA.

WHAT IS NOT COVERED BY THIS WARRANTY?

Your shade may also show some fading and discoloration over time. This is not considered a defect for the purposes of this warranty.

This warranty does not cover the removal or installation of original or replacement shades. This warranty does not cover damage or defects caused by, or resulting from improper maintenance, neglect or improper use, wear and tear, abuse, neglect, accidents, alteration, commercial use, installation, removal or reinstallation or exposure to excessive moisture.

Failure to follow the proper installation, charging and use instructions will invalidate the warranty for motors, remotes and wand motors.

YOUR RIGHTS UNDER STATE LAW

This warranty gives you specific legal rights. You may also have other rights which may vary from State to State. In no event shall we be liable for incidental or consequential damages or for any other direct or indirect damage, loss, cost, expense or fee. Some states do not allow the exclusion or limitation of incidental or consequential damages, so the above limitation or exclusion may not apply to you. This warranty is exclusive and in lieu of all other obligations, liabilities or warranties.

If you have any questions or concerns, please contact Customer Service.